



THERMAL ELECTRIC ELEMENTS  
AUSTRALIA



THERMAL ELECTRIC ELEMENTS  
AUSTRALIA



## Immersion Heaters

Product	Page No.
General Description	9.1
Screw In Type	9.2
Over The Side	9.5
Withdrawable Type	9.9
Heat Coils	9.12

# 9.1

## Immersion Heaters

### Electric Immersion Heaters

Extremely useful in many applications. High heating efficiency and accurate control are maintained due to the heat being generated within the solution. These elements are easily installed and are often used to heat liquids, viscous materials and solids with low melting points. Some common substances include solvents, oil, water, plating baths, salts, wax, paraffin, asphalt and molasses.

Design of shape, sheath and mounting can also be specific to the application. The heat absorption rate of substances will often determine the heat intensity (watt density) of the element. Usually low or mild heat is used for oils and soft metals and more intense heat is required for water and salts.

For accurate temperature control a thermowell is fitted which then allows for single or 3 phase thermostat inclusion.

Most of our product range is manufactured in 316, 321 stainless steel or Incoloy 800 element sheaths. However Thermal can design specific heaters with different sheaths (such as titanium or lead), shapes, sizes, wattages and voltages as required for your application. The heater mounting can also be designed to suit the application and vessel accessibility.

#### TYPES OF IMMERSION HEATERS:

The most common method of applying heat to tank or vessels contents without limiting work area are:

- |                |  |
|----------------|--|
| SCREW IN:      | For small to medium size containers          |
| OVER THE SIDE: | A heavy duty element for portable situations |
| WITHDRAWABLE:  | Tubular                                      |
|                | Ceramic Bobbin                               |

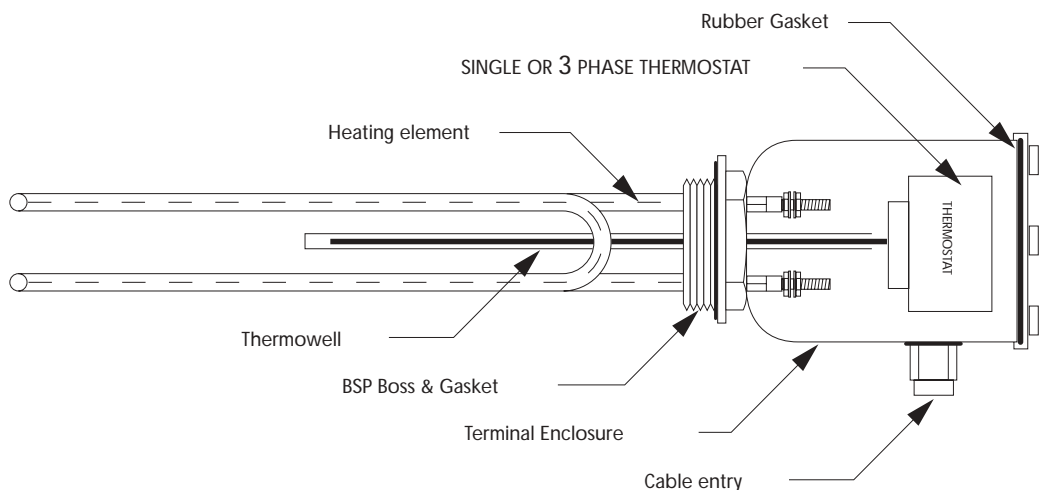

## Immersion Heaters

### Screw In Type

Suitable for small and medium sized containers. The tubular elements are brazed or welded into a BSP bush and a terminal housing is provided for electrical connections.

#### INSTALLATION:

The heater is screwed into a female BSP fitting in the tank or into a pipe coupling or half coupling.

#### APPLICATIONS:

Hot water storage, fluid heating - eg. tar, asphalt, wax, oil, caustic soda, detergent, sterilising equipment, gases.

#### FEATURES:

A compact heater for areas where over the side heaters cannot be used - eg. closed in tanks.

#### OPTIONS:

- Can be manufactured in stainless steel, Incoloy, titanium.
- Various wattages and voltages.
- Various element diameters.
- Several BSP bush sizes available - ranging from 3/8" BSP to 4" BSP
- Assorted shapes - eg. Trombone, U-shaped, triple loop, fold back, coiled
- Several termination variations
- 3 phase - Star or Delta options

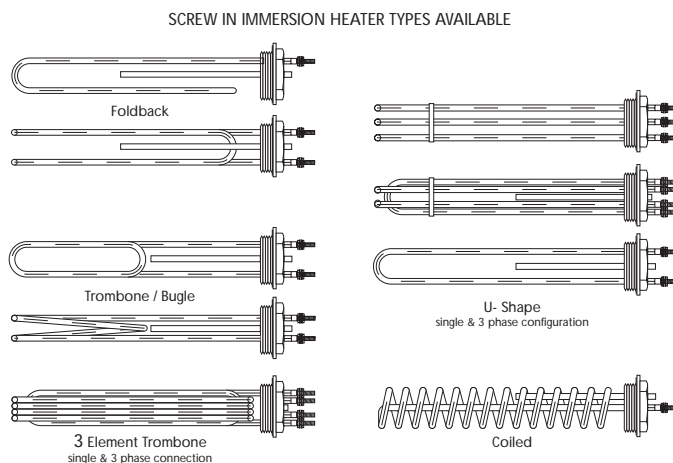

# 9.3

## Immersion Heaters

### 2" BSP CLEAN WATER IMMERSION HEATERS

Part No.	Watts	No. of Elements and shape	Length
TWI 5050	500	1 x U-Shape	250
TWI 50100	1000	1 x U-Shape	250
TWI 50150	1500	1 x U-Shape	250
TWI 50200	2000	1 x Foldback	250
TWI 50240	2400	1 x Foldback	250
TWI 50360	3600	1 x Foldback	300
TWI 50400	4000	3 X U-Shape	250
TWI 50500	5000	3 X U-Shape	250
TWI 50600	6000	3 X U-Shape	300
TWI 50720	7200	3 X U-Shape	350
TWI 50960	9600	3 X U-Shape	425
TWI 501080	10800	3 X U-Shape	500
TWI 501200	12000	3 X U-Shape	550
TWI 501500	15000	3 X U-Shape	650
TWI 502000	20000	3 X U-Shape	850

### 1.25" BSP CLEAN WATER IMMERSION HEATERS

Part No.	Watts	No. of Elements and shape	Length
TWI 3250	500	1 x U-Shape	250
TWI 32100	1000	1 x U-Shape	250
TWI 32150	1500	1 x U-Shape	250
TWI 32200	2000	1 x Foldback	250
TWI 32240	2400	1 x Foldback	250
TWI 32360	3600	1 x Foldback	300
TWI 32400	4000	3 X U-Shape	250
TWI 32500	5000	3 X U-Shape	250
TWI 32600	6000	3 X U-Shape	300
TWI 32720	7200	3 X U-Shape	350
TWI 32960	9600	3 X U-Shape	425
TWI 321080	10800	3 X U-Shape	500
TWI 321200	12000	3 X U-Shape	550
TWI 321500	15000	3 X U-Shape	650
TWI 322000	20000	3 X U-Shape	850

All dimensions given are in millimetres and elements are rated @ 240V each.  
 Units with 3 elements can be used for 240/415V 3 phase star connection.  
 Non standard units can be manufactured to your specific application on request.

## Immersion Heaters

### 2" BSP LIGHT OILS & ALKALINE IMMERSION HEATERS

Part No.	Watts	No. of Elements and shape	Length
TOI5050	500	1 x U-Shape	375
TOI50100	1000	2 x U-Shape	375
TOI50150	1500	3 x U-Shape	375
TOI50200	2000	3 x U-Shape	450
TOI50240	2400	3 x U-Shape	500
TOI50360	3600	3 x U-Shape	700
TOI50400	4000	3 x U-Shape	900
TOI50500	5000	3 x Trombone	750
TOI50600	6000	3 x Trombone	900
TOI50720	7200	3 x Trombone	1050
TOI50960	9600	3 x Trombone	1300
TOI501080	10800	3 x Trombone	1425

### 1.25" BSP LIGHT OILS & ALKALINE IMMERSION HEATERS

Part No.	Watts	No. of Elements and shape	Length
TOI3250	500	1 x U-Shape	375
TOI32100	1000	2 x U-Shape	375
TOI32150	1500	3 x U-Shape	375
TOI32200	2000	3 x U-Shape	450
TOI32240	2400	3 x U-Shape	500
TOI32360	3600	3 x U-Shape	700
TOI32400	4000	3 x U-Shape	900
TOI32500	5000	3 x U-Shape	1090
TOI32600	6000	3 x U-Shape	1350

All dimensions given are in millimetres and elements are rated @ 240V each.  
 Units with 3 elements can be used for 240/415V 3 phase star connection.  
 Non standard units can be manufactured to your specific application on request.

# 9.5

## Immersion Heaters

### Over The Side

Portable over the side immersion heaters are compact and portable enough to move from tank to tank and guarantee minimal interference with the production process. They can easily be re-positioned along the tank wall to improve heat distribution and are ideal where removal of the heater is required for periodic cleaning and inspection of the tank.

These heaters are available for heating water, light weight oils, salt baths, alkaline cleaning solutions, cyanide plating solutions, citric juices, acid baths and other corrosive liquids.

Standard units up to 4000W come complete with terminal enclosure and thermostat control. If our stock range of heaters are not suited to your application, then custom manufactured units can be produced to suit your requirements.

#### INSTALLATION:

Simply place over side wall of tank.

#### FEATURES:

- Portable
- Economical
- Ease of maintenance

#### APPLICATIONS:

Heating all solutions where drainage of the tank is impractical.

#### OPTIONS:

- Can be manufactured in stainless steel, Incoloy, titanium, lead
- Various wattages and voltages
- Various element diameters
- Terminal enclosure fully moisture resistant
- Rubber seals
- 3 phase -Star or Delta options
- Digital temperature controls
- Programmable timers
- Various watt densities

# 9.6

## INFORMATION REQUIRED WHEN ENQUIRING:

1. Length of tank
2. Depth of tank
3. Solution to be heated
4. Available power supply
5. Minimum liquid level
6. Time to heat to Temp

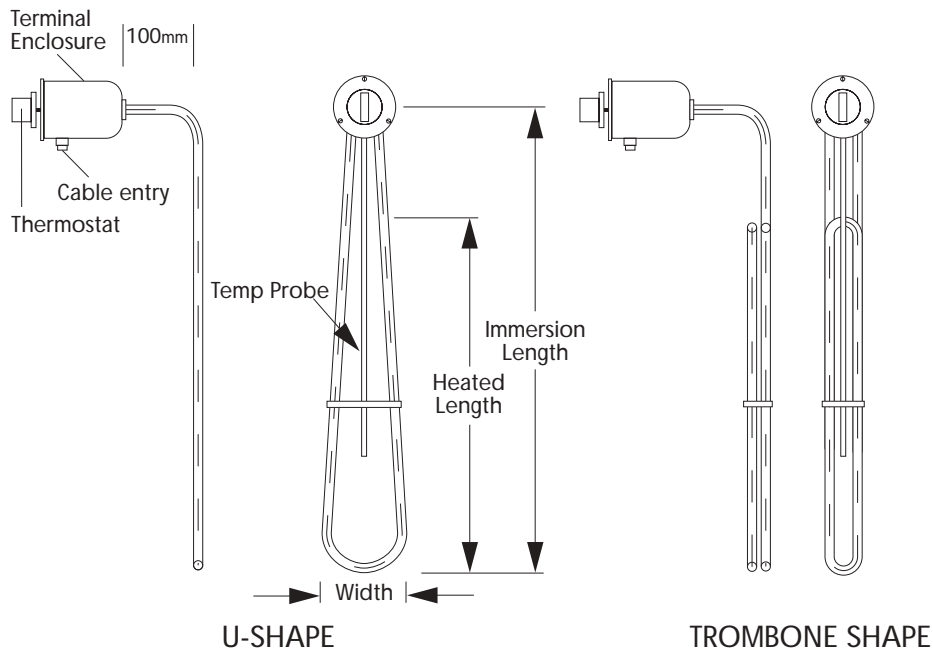

## PORTABLE - OVER THE SIDE IMMERSION HEATERS

Part No.	Watts	Sheath	Shape	Width	Immersion Length	
					TOTAL	HEATED
OTS100	1000	INC 800	U-Shape	100	500	300
OTS200	2000				650	450
OTS300	3000				850	650
OTS400	4000				1050	850
OTS500	5000				1300	1100
OTS600	6000				1500	1300
OTS1100	1000	INC 825	U-Shape	100	500	300
OTS1200	2000				650	450
OTS1300	3000				850	650
OTS1400	4000				1050	850
OTS1500	5000				1300	1100
OTS1600	6000				1500	1300
OTSS100	1000	7.9Ø 32lss Low Watt Density Oil Immersed	Trombone	100	575	375
OTSS200	2000				825	625
OTSS300	3000				1200	1000
OTSS400	4000				1500	1300
OTSS500	5000				1825	1625
OTSS600	6000				2000	1800

\* All dimensions are in millimetres

# 9.7

## Immersion Heaters

### PORTABLE - OVER THE SIDE IMMERSION HEATERS

Cat No.	Watts	Sheath	Shape	Width	Immersion Length	
					TOTAL	HEATED
OTST100	1000	Titanium	U-Shape	150	500	300
OTST200	2000				650	450
OTST300	3000				850	650
OTST400	4000				1050	850
OTST500	5000				1300	1100
OTST600	6000				1500	1300
OTSL100	1000	Lead	U-Shape	150	560	360
OTSL200	2000				700	500
OTSL300	3000				880	680
OTSL400	4000				1050	850
OTSL500	5000				1310	1110
OTSL600	6000				1500	1300
OTS1100H	1000	Inc 800 High Watt Density Water Immersed	U-Shape	50	300	150
OTS1200H	2000				500	350
OTS1300H	3000				575	425
OTS1400H	4000				750	600
OTS1500H	5000				975	725
OTS1600H	6000				1050	900

\* All dimensions are in millimetres

## Immersion Heaters

### Special Over The Side Immersion Heaters

Suitable for square, rectangular or circular tanks. Single or 3 phase units with element multiples of 3 and stage wired.

INFORMATION REQUIRED WHEN ENQUIRING:

1. Length of tank
2. Depth of tank
3. Solution to be heated
4. Available power supply
5. Minimum liquid level
6. Temperature required
7. Time to heat solution

OPTIONS:

- Programmable timers
- Controllers
- Stage heating
- Fully water resistant control enclosure

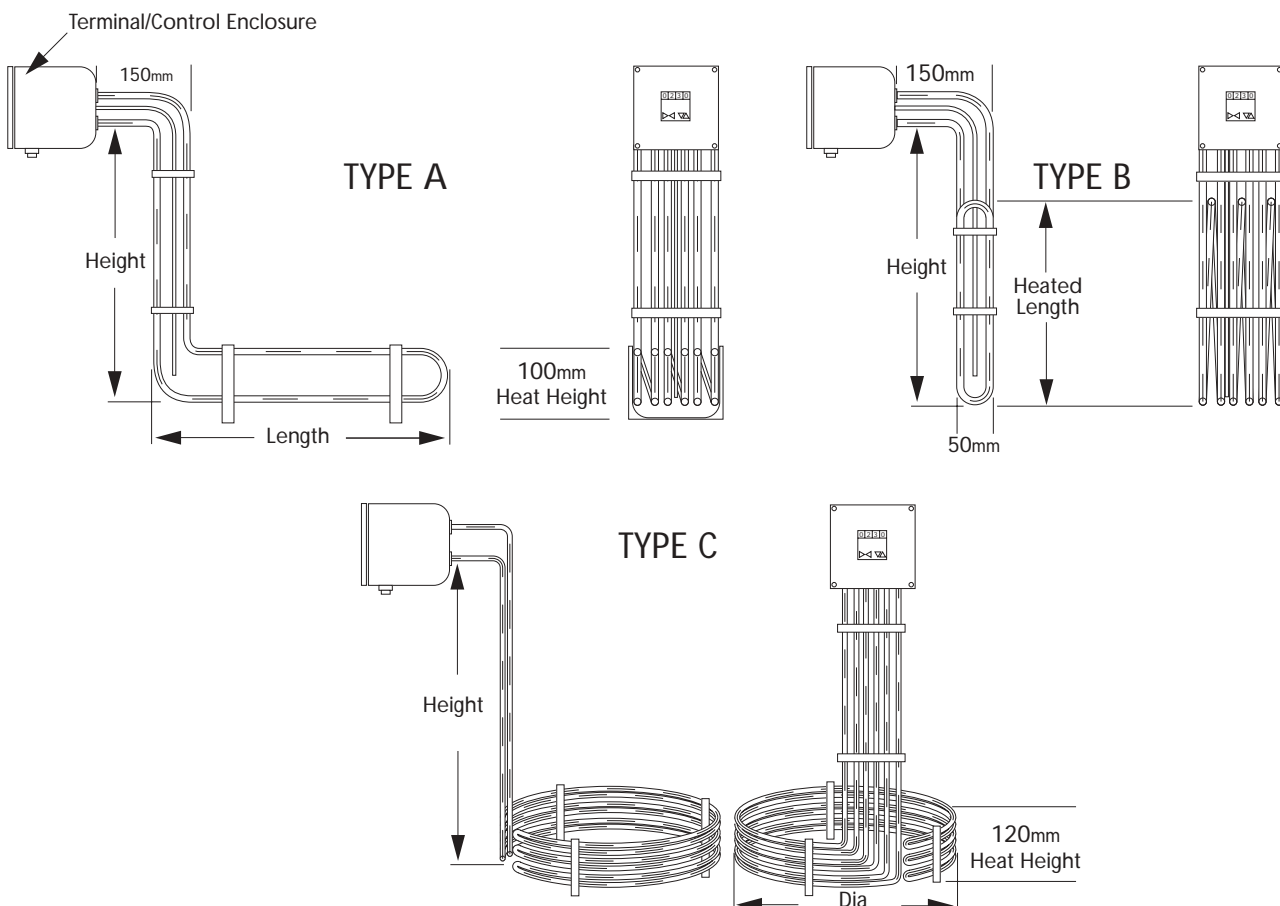

# 9.9

## Immersion Heaters

### Withdrawable Type

#### TUBULAR:

S.S. sheathed alternative to the standard ceramic bobbin type. The withdrawable tubular has been designed and manufactured to outlast its ceramic counterpart, which is fragile and will deteriorate much sooner through physical damage. Tubular withdrawables are suitable for applications where replacement or repairs are to be carried out without disturbing the contents of the tank.

#### INSTALLATION:

This is achieved by inserting the withdrawable tubular element into a nominal diameter pipe - commonly known as the thermowell - ranging from 50mm diameter for standard units, up to 100mm diameter for specials. The thermowell may be a permanent fixture of the tank or it can be supplied as a separate removable tube with 2" BSP boss which can then be fitted to a mating tank socket.

#### FEATURES:

Robust, suitable for harsh conditions and extremely resistant to mechanical or physical abuse, or where vibration may occur.

#### APPLICATIONS:

Suitable for all solutions where drainage of the tank is impractical and where direct heating is not achievable or recommended. Materials such as bitumen, wax, fats and oils require low element surface temperatures to prevent product degradation.

#### OPTIONS:

- Can be manufactured in stainless steel or Incoloy
- Various wattages and voltages
- Various element diameters
- Can be manufactured to Zone 1 Class 1 standards
- Several terminal variations

# 9.10

## THERMAL WITHDRAWABLE TUBULAR TYPE

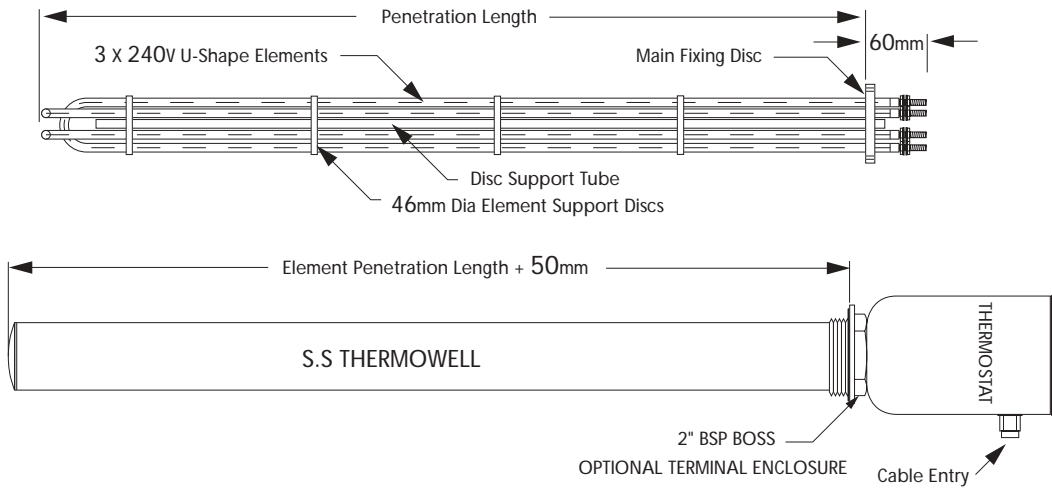

THERMAL WITHDRAWABLE TUBULAR					
Part No.	Watts	Volts	Length	Watt Density	
				$\text{kW/m}^2$	$\text{W/in}^2$
TWT-65A	750	240	650	8	5
TWT-65B	1500	240	650	16	10
TWT-65C	3000	240/415	650	31	20
TWT-80A	900	240	800	8	5
TWT-80B	1800	240	800	16	10
TWT-80C	3600	240/415	800	31	20
TWT-85A	1000	240	850	8	5
TWT-85B	2000	240	850	16	10
TWT-85C	4000	240/415	850	31	20
TWT-105A	1200	240	1050	87	5
TWT-105B	2400	240	1050	16	10
TWT-105C	4800	240/415	1050	31	20
TWT-125A	1200	240	1250	8	5
TWT-125B	3000	240	1250	16	10
TWT-125C	6000	240/415	1250	31	20
TWT-150A	1800	240	1500	8	5
TWT-150B	3600	240/415	1500	16	10
TWT-150C	6000	240/415	1500	31	20
TWT-165A	2000	240	1650	8	5
TWT-165B	4000	240/415	1650	16	10
TWT-165C	8000	240/415	1650	31	20
TWT-205A	2500	240	2050	8	5
TWT-205B	5000	240/415	2050	16	10
TWT-205C	10000	240/415	2050	31	20
TWT-250A	3000	240/415	2500	8	5
TWT-250B	6000	240/415	2500	16	10
TWT-250C	12000	240/415	2500	31	20
TWT-305A	3750	240/415	3050	8	5
TWT-305B	7500	240/415	3050	16	10
TWT-305C	15000	240/415	3050	31	20
TWT-330A	4000	240/415	3300	8	5
TWT-330B	8000	240/415	3300	16	10
TWT-330C	16000	240/415	3300	31	20
TWT-410A	5000	240/415	4100	8	5
TWT-410B	10000	240/415	4100	16	10
TWT-410C	20000	240/415	4100	31	20

NOTE:  $8\text{kW/m}^2$  ( $5\text{W/in}^2$ ) for bitumen, tar, fuel oil.

$16\text{kW/m}^2$  ( $10\text{W/in}^2$ ) for heat transfer oil, hydraulic & turbine oils, vegetable oil storage, waxes & tallow storage.

$32\text{kW/m}^2$  ( $20\text{W/in}^2$ ) for soluble oils, emulsions, engine oil & general lubricants, water.

\* All dimensions are in millimetres

# 9.11

## Immersion Heaters

### CERAMIC BOBBIN:

An alternative to the S.S. tubular type which is also suitable for applications where replacement or repairs are to be carried out without disturbing the contents of the tank.

### INSTALLATION:

Achieved by inserting the ceramic bobbin into a 50mm nominal dia tube commonly known as the thermowell. The thermowell may be a permanent fixture of the tank or it can be supplied as a separate removable tube with 2" BSP boss which then can be fitted to the mating tank socket.

### APPLICATIONS:

As per withdrawable tubulars.

Please note Ceramic Bobbins are **MADE TO ORDER ONLY**.

### INFORMATION REQUIRED WHEN ENQUIRING:

1. Voltage
2. Number of phases
3. Wattage
4. Penetration length
5. Cold length

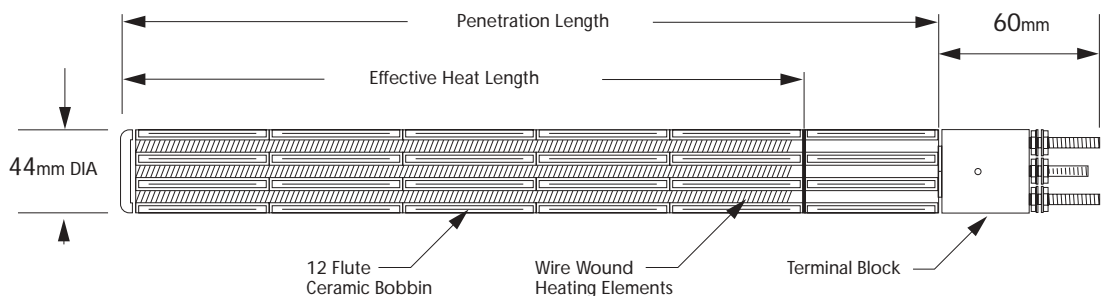

## Immersion Heaters

### Thermal Heat Coils

The heat coil series of heaters are manufactured in Australia and are designed for use in the chemical, electroplating and metal finishing industries. A robust design with heaters being manufactured from 316SS, Incoloy and Titanium sheaths ensuring a long lasting reliable and hassle free package.

**Teflon Heat Coils** are used in solutions where previously only Vitrosol or Quartz heaters were available. Now a robust package is here! No fragile sheaths, no cracking or breakages. A reliable and rigid Incoloy metal sheathed element with a non contaminating, chemical resistant Teflon sleeve. A 0.75mm wall thickness of teflon gives a safe barrier between the solution and the heating element.

Teflon heat coils are compatible with most plating tank solutions and are inert to acids, pickling and anodising solutions up to 90°C.

#### OPTIONAL EXTRAS:

- S.S. terminal/control enclosures
- Standard or digital temperature controls
- Various voltages and wattages available on request
- 90° angled terminal enclosure to tank

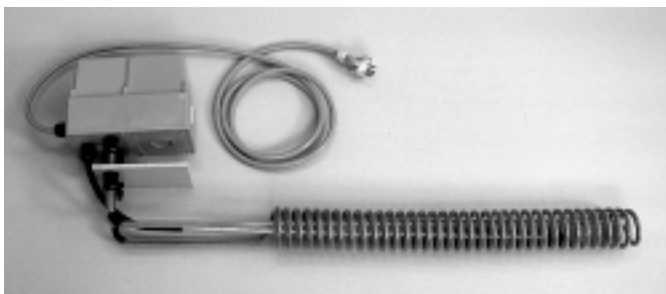

# 9.13

## Immersion Heaters

### Heat Coils

#### Teflon Series - HCT

Part No.	Wattage	Penetration	Heated	Dia
HCT05	500	300	200	60
HCT10	1000	500	300	60
HCT20	2000	600	400	60
HCT30	3000	750	500	60

#### Titanium Series - HCTi

Part No.	Wattage	Penetration	Heated	Dia
HCTi05	500	300	200	60
HCTi10	1000	500	300	60
HCTi20	2000	600	400	60
HCTi30	3000	750	500	60
HCTi40	4000	850	600	60
HCTi50	5000	950	700	90
HCTi60	6000	1050	800	90

#### Stainless Steel Series - HCS

Part No.	Wattage	Penetration	Heated	Dia
HCS05	500	300	200	60
HCS10	1000	500	300	60
HCS20	2000	600	400	60
HCS30	3000	750	500	60
HCS40	4000	850	600	60
HCS50	5000	950	700	90
HCS60	6000	1050	800	90

Immersion Heaters

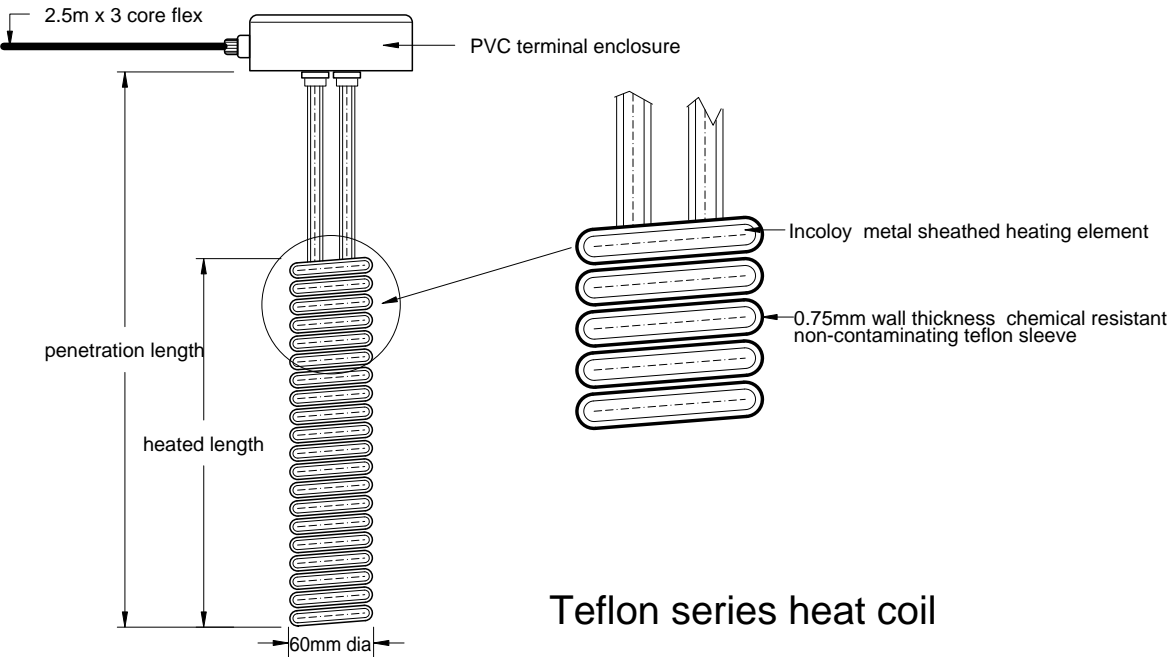

Teflon series heat coil

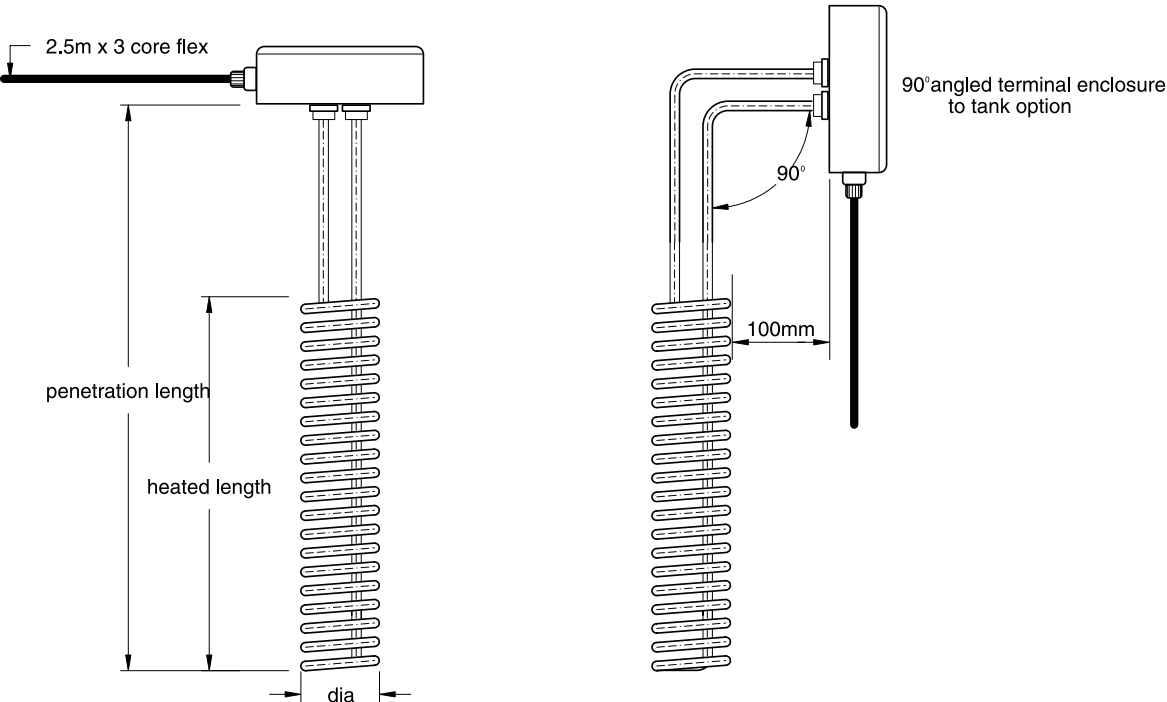

Titanium & stainless steel series heat coil